

STÄDTISCHES MOBILIAR MOBILIER URBAIN ARREDO URBANO

CH-6930 Bedano (Lugano)

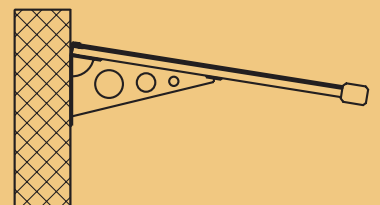

CARPORT.11

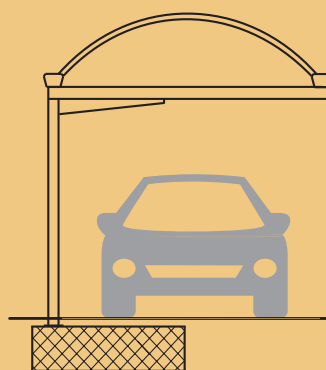
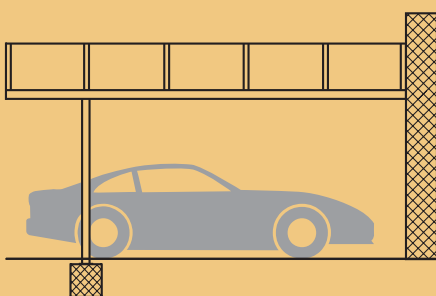

Société

Depuis 1989, de nombreuses administrations publiques et privées se sont adressées à nous pour l'aménagement de rues, de places, de parcs publics, etc....

Une réussite qui repose principalement sur 3 points:

La qualité

Nos produits sont conçus pour répondre aux exigences d'une utilisation quotidienne intense et résister aux dommages causés par les conditions atmosphériques.

La gamme des jeux correspond aux normes EN 1176 e EN 1177.

Le choix

est actuellement le plus vaste et complet sur le territoire suisse.

Périodiquement de nouveaux produits, au design et aux matériaux innovateurs, viennent compléter ceux déjà existants.

Le service

est une base essentielle de la philosophie de notre société.

Nous garantissons une assistance dans les différentes phases de conception d'un projet, du montage et du service après vente grâce à des équipes présentes sur toute la Suisse.

Seit
depuis
dal
1989

A-Z SA
via industrie 18
CH-6930 Bedano
www.az-sa.ch
info@az-sa.ch

INDEX

CARPORT

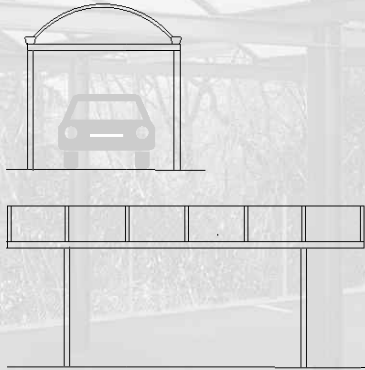

Série TE30

p.4

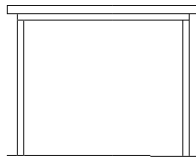

Série TE80

p.6

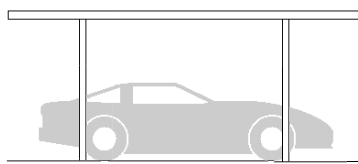

Série TE85

p.8

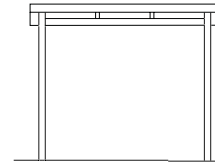

Série TE100

p.10

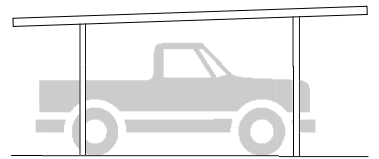

COUVERTURES D'ENTRÉE

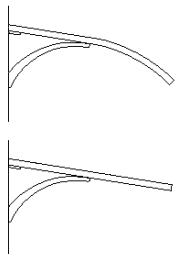

Série Light R-F

p.12

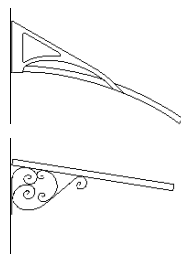

Série Lux R-F

p.14

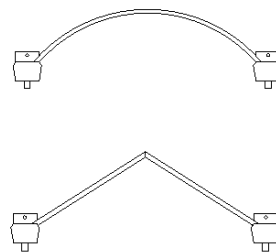

Série Lux VR-VE

p.16

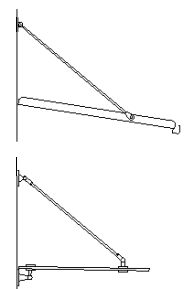

Série à tirants

p.18

COUVERTURES D'ESCALIERS ET PASSAGES

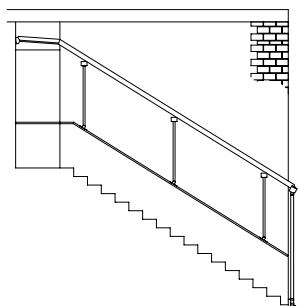

Escaliers

p.20

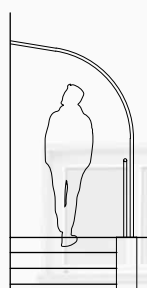

Passages

p.20

COUVERTURES DE TERRASSES

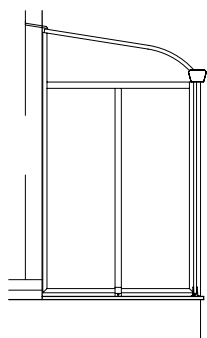

Série R

p.22

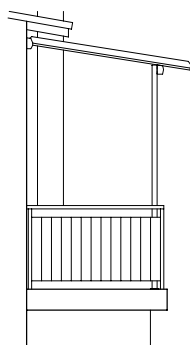

Série F

p.24



DIVERS

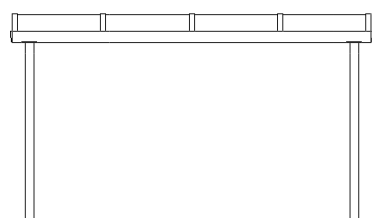

Pergola

p.26

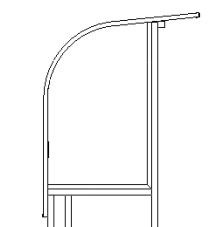

Couvert pour joueurs

p.28

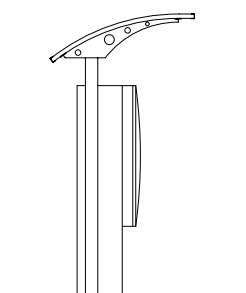
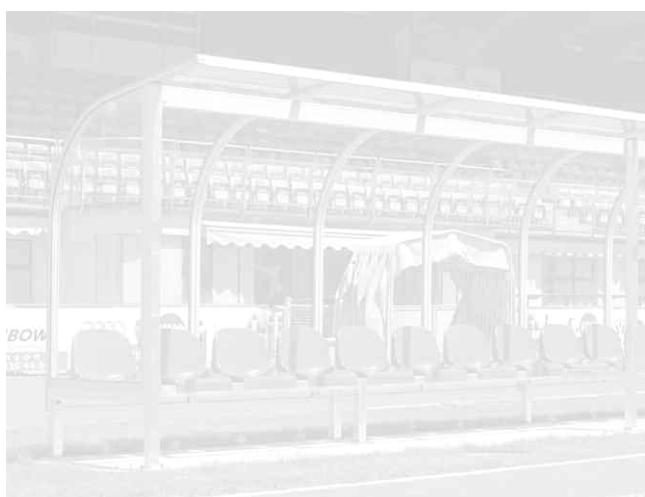

Distributeurs

p.30

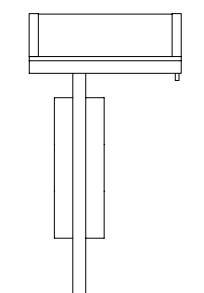

Boîtes aux lettres

p.30





01

CARPORT TE30

Couverts en forme d'arc et pyramidale au design classique et simple.

Chaque structure est construite sur mesure et respecte les contraintes statiques du lieu où elle sera installée.



02



03



04



05



Service
de montage en
Suisse romande

Caractéristiques principales

Structure portante composée de colonnes et traverses en profilés d'acier zingué à chaud ou sablé et thermolaqué

Couverture supérieure en profilés d'aluminium; chéneau portant TE30 et extrudés de fermetures. Finition en aluminium anodisé ou en teinte Perlgrimm gris anthracite

Plaques de recouvrement en plexiglas Röhm XT 4 mm – 4 teintes à choix

Sur demande: dimensions et constructions spéciales, teintes RAL, prédisposition illumination LED



CARPORT

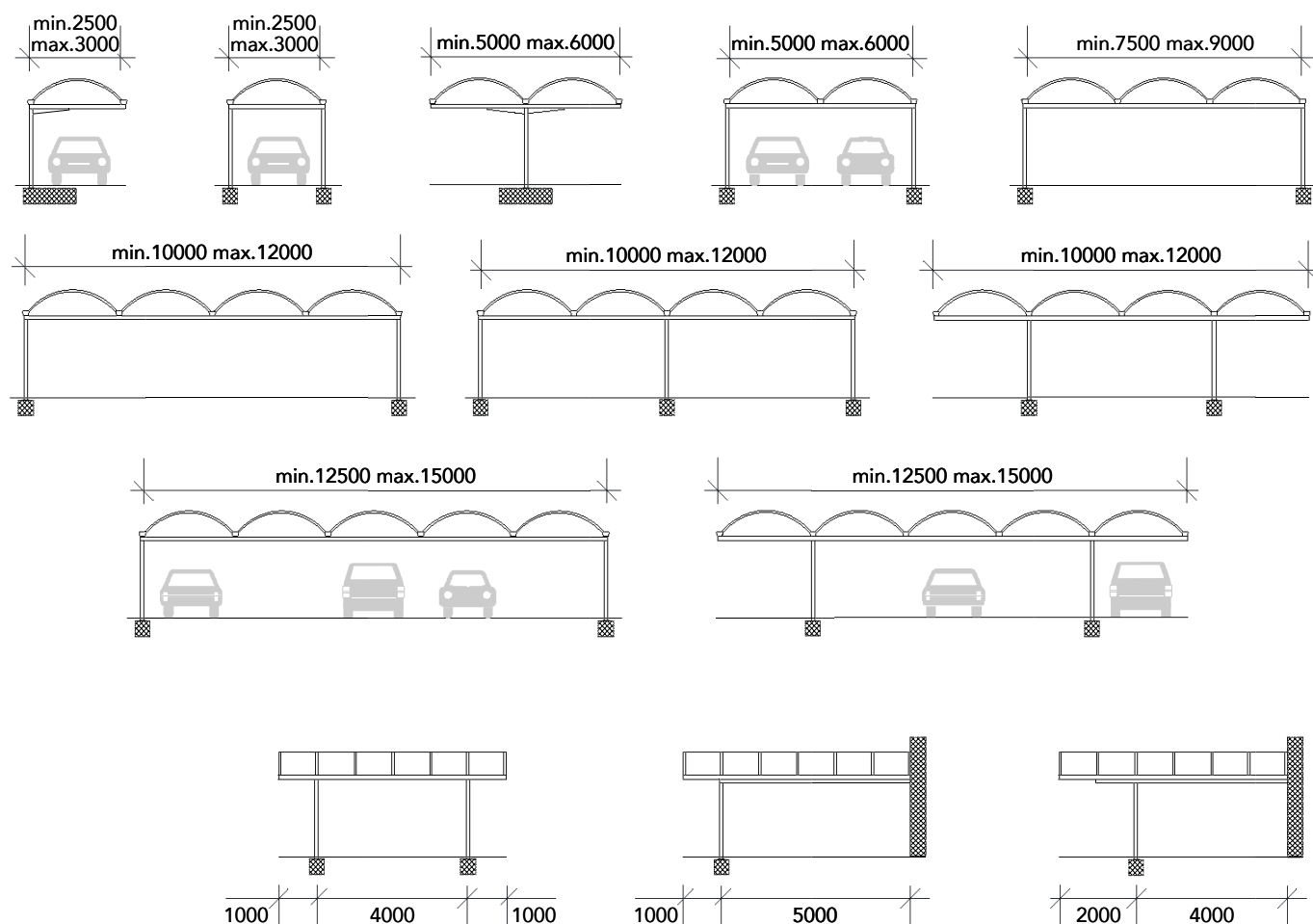

07

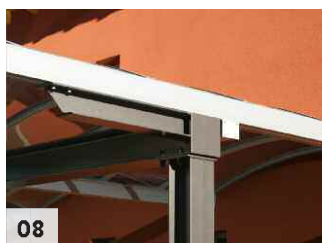

08



09



10



CARPORT TE80

Couverts à toiture plate au design épuré et moderne. Une très légère pente du toit permet une bonne évacuation de l'eau pluviale.

Chaque structure est construite sur mesure et respecte les contraintes statiques du lieu où elle sera installée.

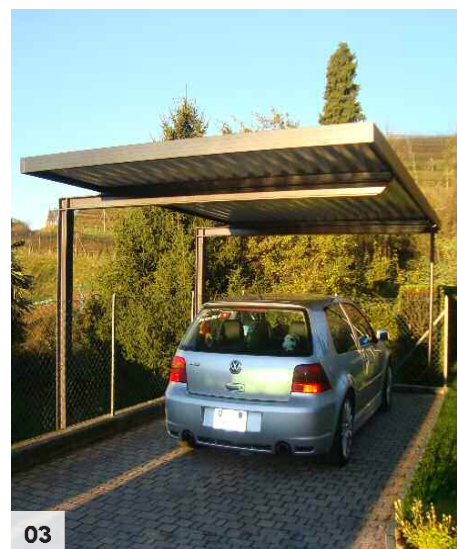
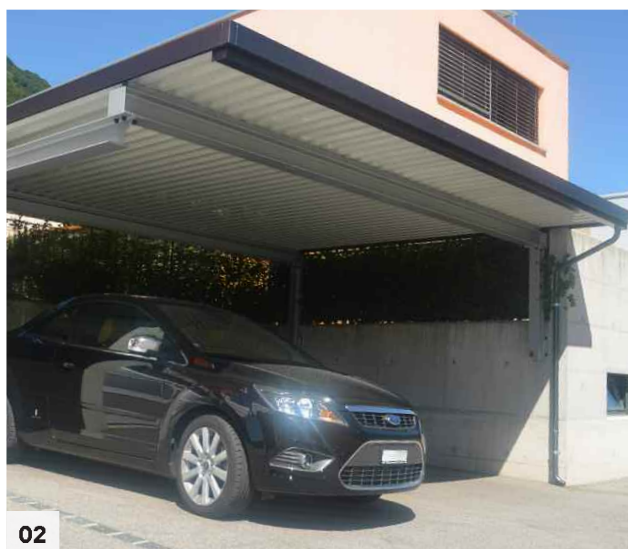

Service
de montage en
Suisse romande

Caractéristiques principales

Structure portante composée de colonnes et traverses en profilés d'acier zingué à chaud ou sablé et thermolaqué

Couverture supérieure en profilés d'aluminium TE80 permet de contenir les panneaux de couverture.

Plaque de recouvrement en tôles ondulées d'acier traité type SP45 ou 80; finition teinte alu RAL 9006 (face supérieure) et gris RAL 7045 (face inférieure)

Sur demande: dimensions et constructions spéciales, teintes RAL, prédisposition illumination LED

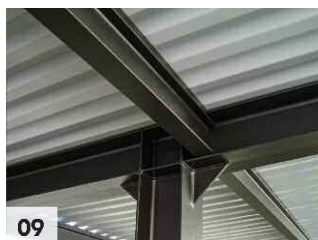
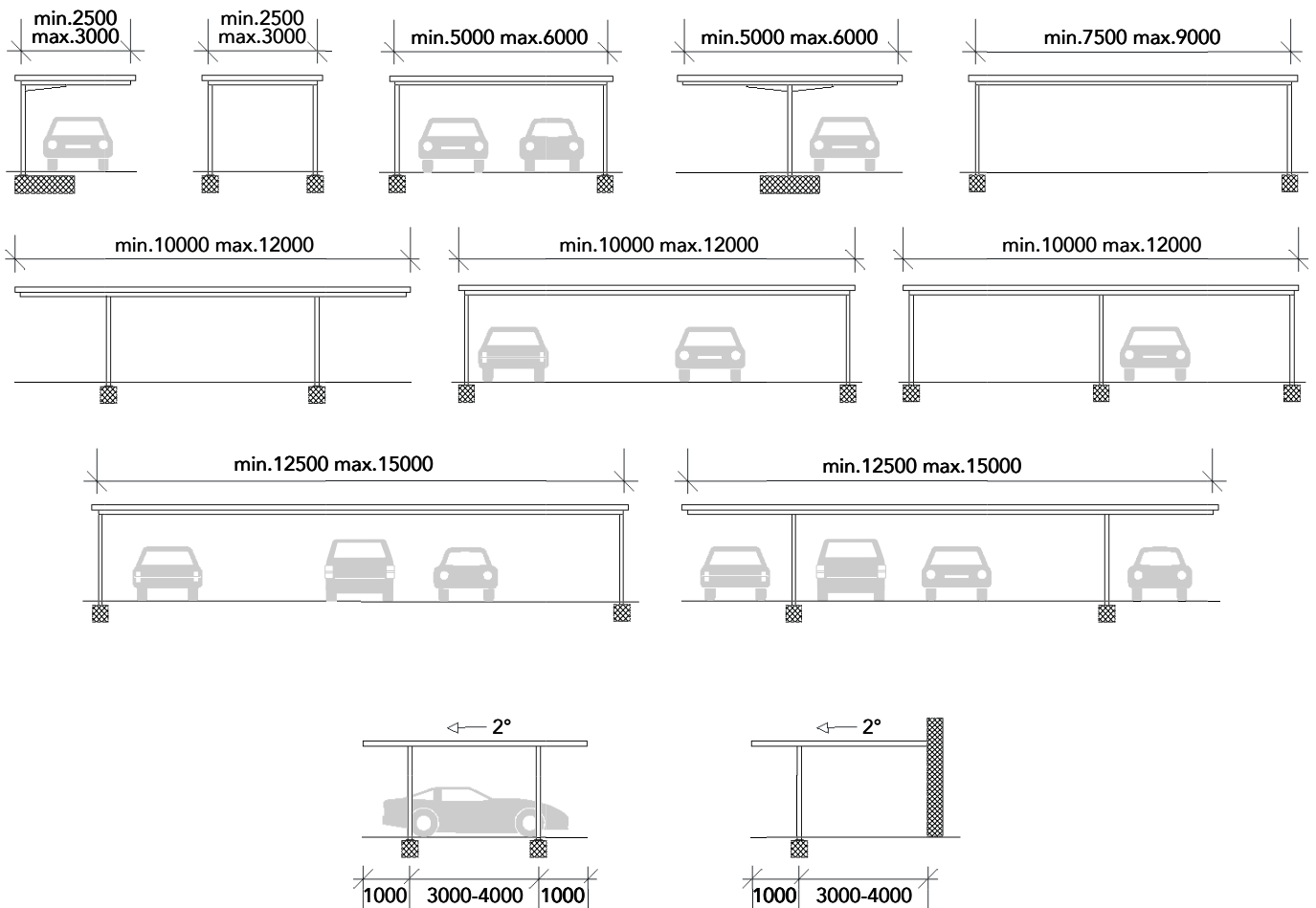

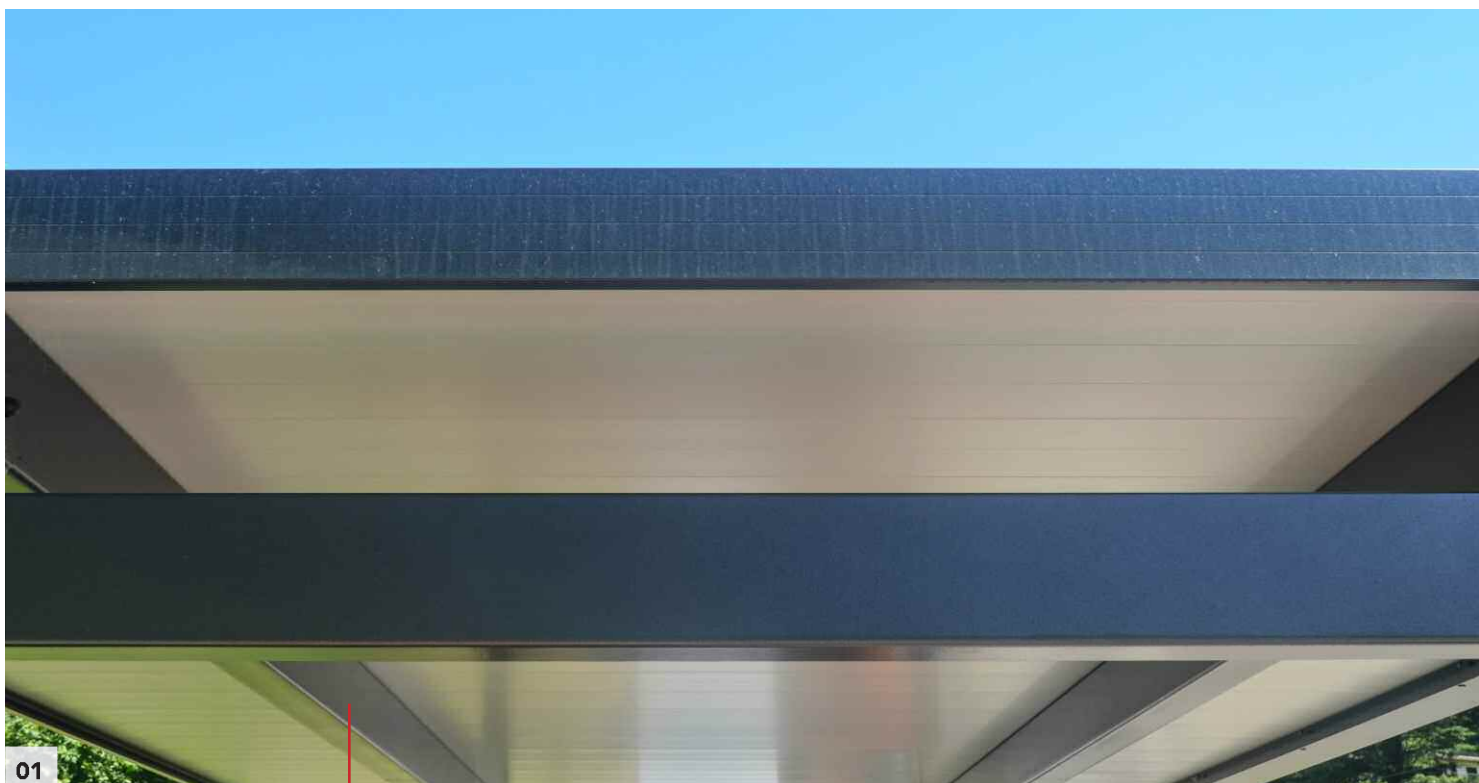

01

CARPORT TE85

Couverts à toiture plate au design contemporain. La couverture est intégralement en aluminium. Chaque structure est construite sur mesure et respecte les contraintes statiques du lieu où elle sera installée.



Service
de montage en
Suisse romande



02



03



04



05

Caractéristiques principales

Structure portante composée de colonnes et traverses en profilés d'acier zingué à chaud ou sablé et thermolaqué
 Couverture supérieure en profilés d'aluminium TE85 permet de contenir les panneaux de couverture. Finition en aluminium anodisé ou en teinte Perlgrimm gris anthracite
 Couverture formée de profilés d'aluminium encastrables offrant une surface visible lisse et propre; finition teinte gris RAL 7035
 Sur demande: dimensions et constructions spéciales, teintes RAL, prédisposition illumination LED

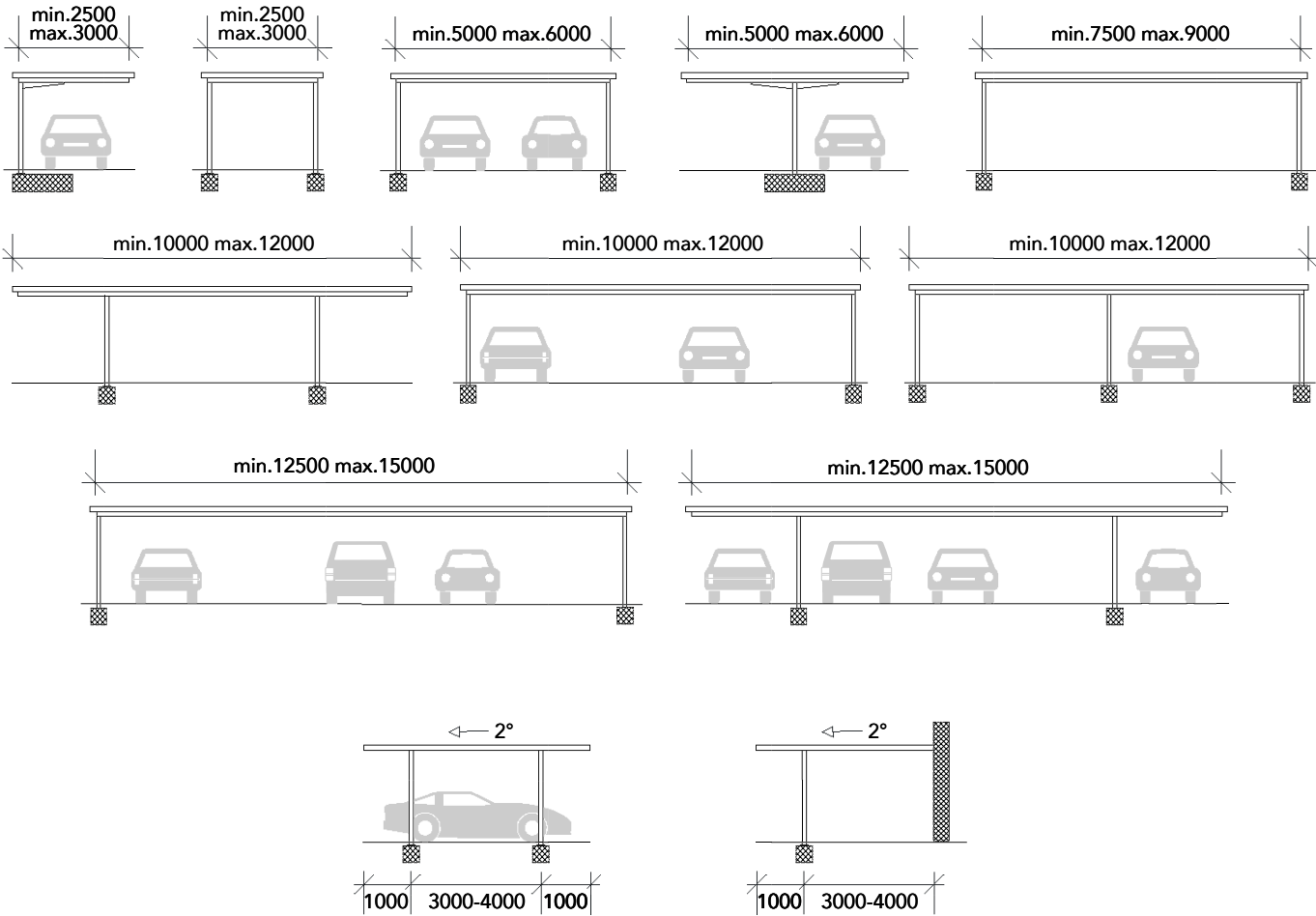



01

CARPORT TE100

Couverts à toiture plate au design simple et élégant. Couverture translucide grâce à un matériau moderne et garanti 20 ans contre les U.V.

Chaque structure est construite sur mesure et respecte les contraintes statiques du lieu où elle sera installée.



02



03

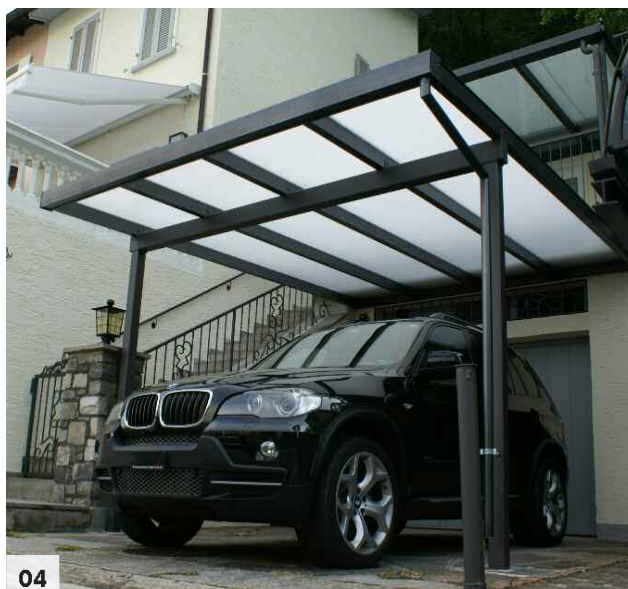

04



05



Service
de montage en
Suisse romande

Caractéristiques principales

Structure portante composée de colonnes et traverses en profilés d'acier zingué à chaud ou sablé et thermolaqué
 Couverture supérieure en profilés d'aluminium TE100 permet de contenir les panneaux de couverture. Finition en aluminium anodisé ou en teinte Perlgrimm gris anthracite

Couverture formée de plaques en Plexiglas alvéolaire Röhm SDP 16 mm – 2 teintes à choix

Sur demande: dimensions et constructions spéciales, teintes RAL, prédisposition illumination LED

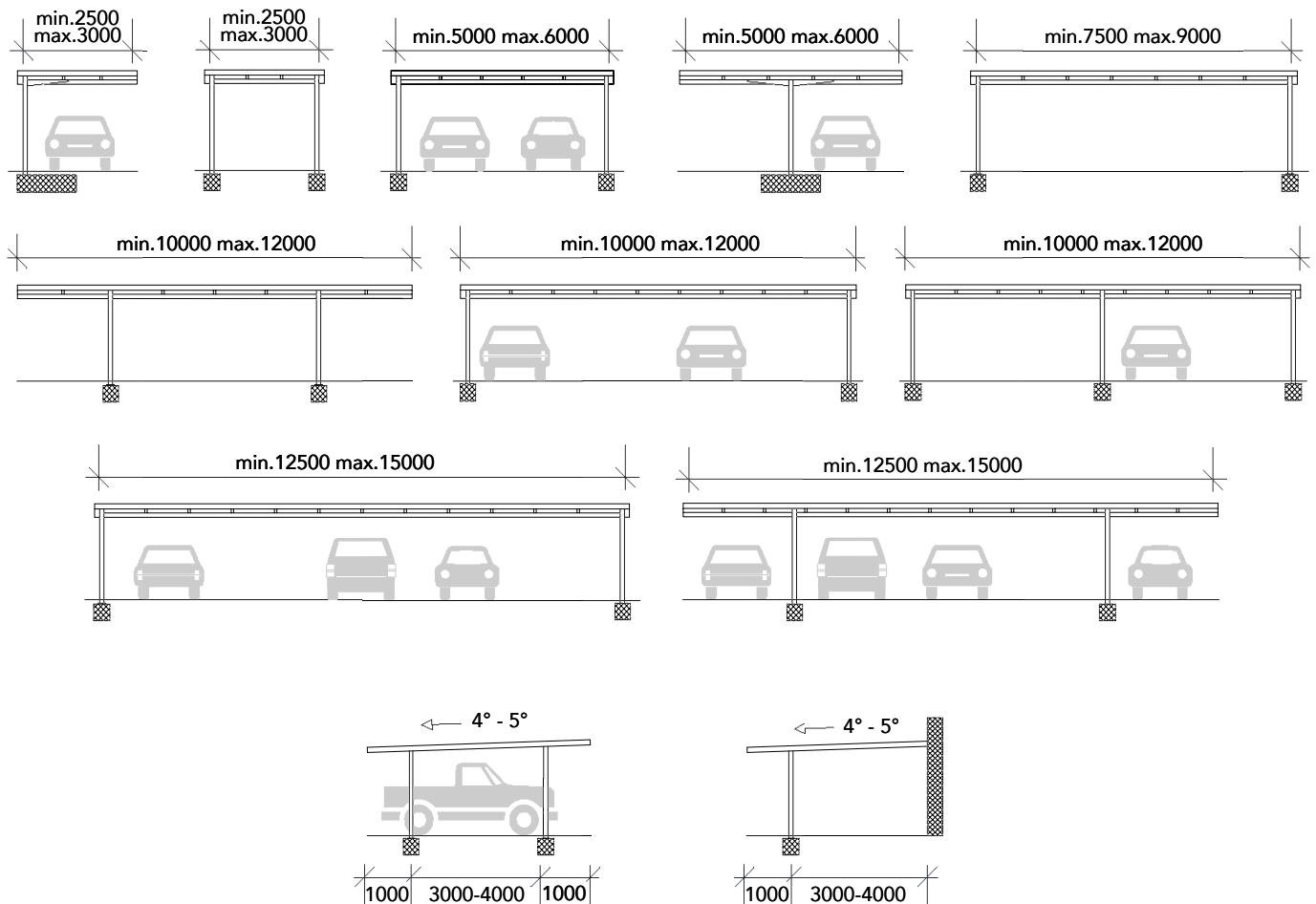



Couverts d'entrée Light R-F

Couverture translucide grâce à un matériau moderne et garanti 20 ans contre les U.V.

Chaque structure est construite sur mesure et respecte les contraintes statiques du lieu où elle sera installée.

La ligne Light est une ligne simple qui s'intégrera parfaitement à votre bâtiment.



Service de montage en Suisse romande

Caractéristiques principales

Structure portante composée de consoles murales en aluminium thermolaqué teinte alu RAL 9006 ou gris anthracite

Couverture supérieure en profilés d'aluminium; canal pour les eaux pluviales en extrudé. Finition en aluminium anodisé ou en teinte gris anthracite

Plaques de recouvrement en plexiglas Röhm XT 4 mm - 4 teintes à choix

Sur demande: dimensions et constructions spéciales, teintes RAL, pipette d'évacuation des eaux, prédisposition illumination LED

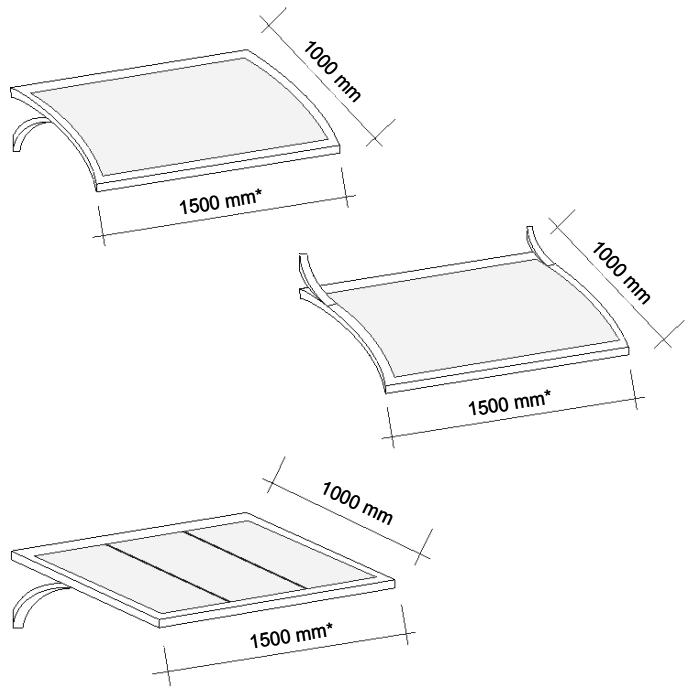

* Mesures standards conseillées pour une porte d'entrée

Modèle R

LIGHT AS.R.081

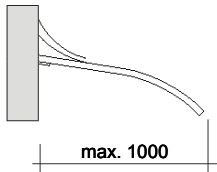

LIGHT A.R.081

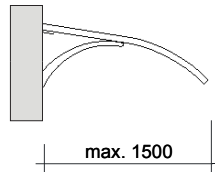

Modèle F

LIGHT A.F.081

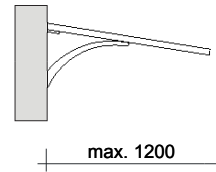

LIGHT AS.R.082

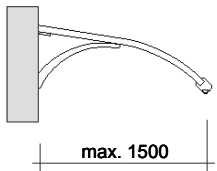

LIGHT A.R.082

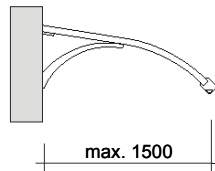

LIGHT A.F.082

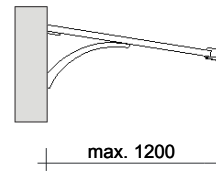



01

Couverts d'entrée Lux R-F

Couverture translucide grâce à un matériau moderne et garanti 20 ans contre les U.V.

Chaque structure est construite sur mesure et respecte les contraintes statiques du lieu où elle sera installée.

La ligne Lux est une ligne plus classique et intemporelle.



Service de montage en Suisse romande

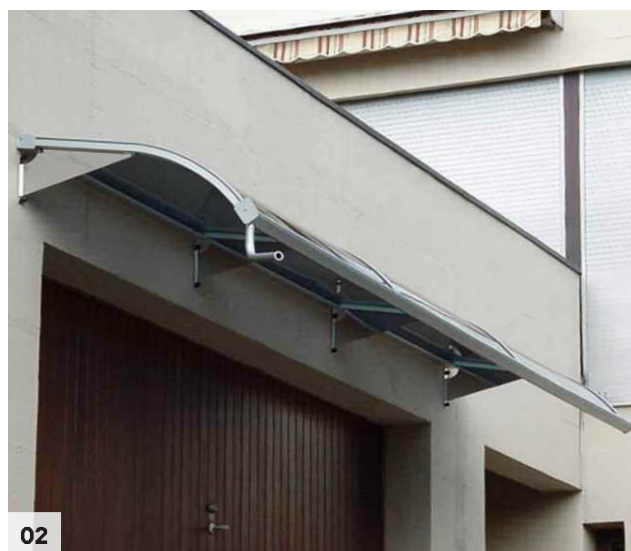

02



03



04



05

Caractéristiques principales

Structure portante composée de consoles murales en tôles d'acier inox ou fer forgé selon le modèle. Elles seront thermolaquées teinte alu RAL 9006 ou gris anthracite

Couverture supérieure en profilés d'aluminium; canal pour les eaux pluviales en extrudé. Finition en aluminium anodisé ou en teinte gris anthracite

Plaques de recouvrement en plexiglas Röhm XT 4 mm - 4 teintes à choix

Sur demande: dimensions et constructions spéciales, teintes RAL, pipette d'évacuation des eaux, prédisposition illumination LED

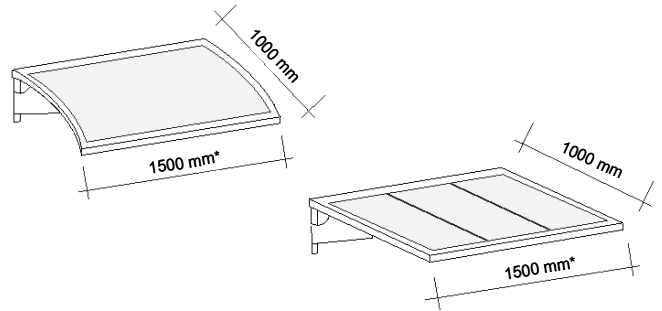

* Mesures standards conseillées pour une porte d'entrée

Modèle F

Mod. LUX TI.F.081

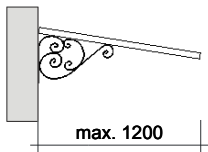

Mod. LUX TI.F.082

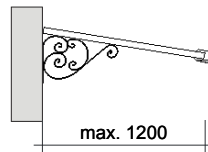

Mod. LUX EC.F.081

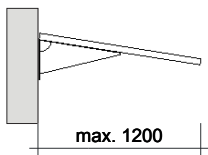

Mod. LUX EC.F.082

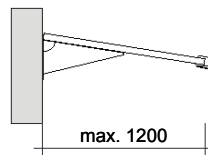

Mod. LUX AR.F.081

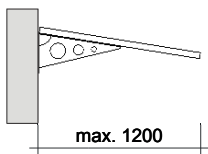

Mod. LUX AR.F.082

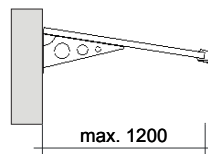

Modèle R

Mod. LUX AS.R.081

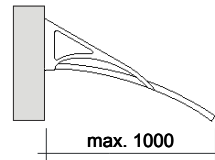

Mod. LUX AS.R.082

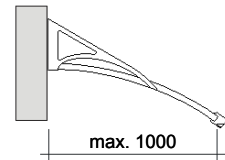

Mod. LUX TI.R.081

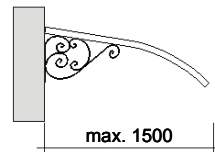

Mod. LUX TI.R.082

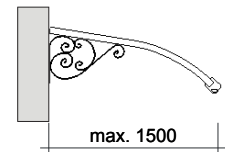

Mod. LUX EC.R.081

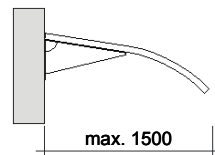

Mod. LUX EC.R.082

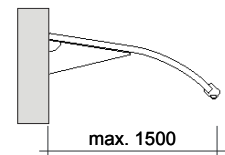

Mod. LUX AR.R.081

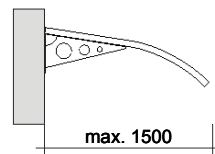

Mod. LUX AR.R.082

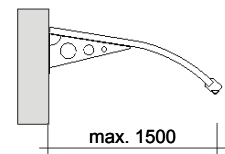



01

Couverts d'entrée Lux VR-VE

Couverture translucide grâce à un matériau moderne et garanti 20 ans contre les U.V.

Chaque structure est construite sur mesure et respecte les contraintes statiques du lieu où elle sera installée.

En forme de coupole ou pyramidale.



02



03



04



05



Service de montage en Suisse romande

Caractéristiques principales

Structure portante composée de profilés spéciaux TE25 en extrudés d'aluminium qui servent également de chéneaux. Ils seront thermolaqués teinte alu RAL 9006 ou gris anthracite

Couverture supérieure en profilés d'aluminium. Finition en aluminium anodisé ou en teinte gris anthracite

Plaques de recouvrement en plexiglas Röhm XT 4 mm - 4 teintes à choix

Sur demande: dimensions et constructions spéciales, teintes RAL, pipette d'évacuation des eaux, prédisposition illumination LED

Système TE25

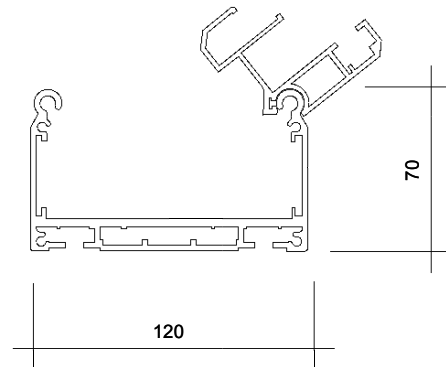

Mod. LUX VR TE 25

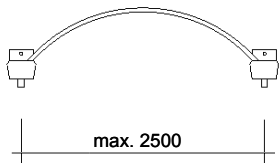

Modules complémentaires

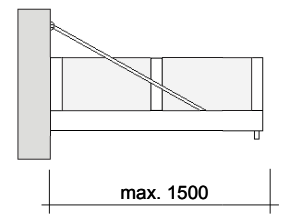
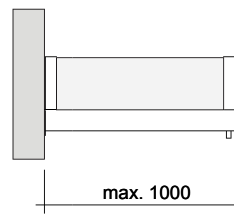
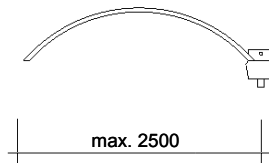

Mod. LUX VE TE 25

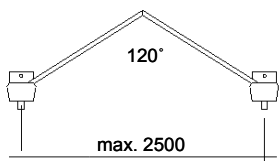

Modules complémentaires

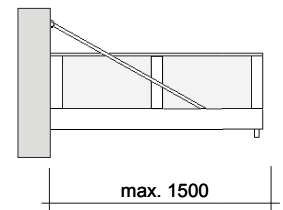
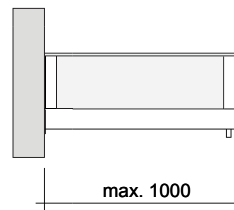
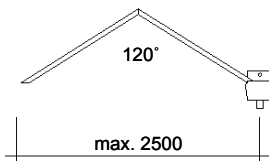

06



07



08



09



Couverts d'entrée à tirants

Couvertures à tirants, idéales lorsque la situation ne permet pas l'installation de consoles ou lorsque un grand porte à faux est demandé.

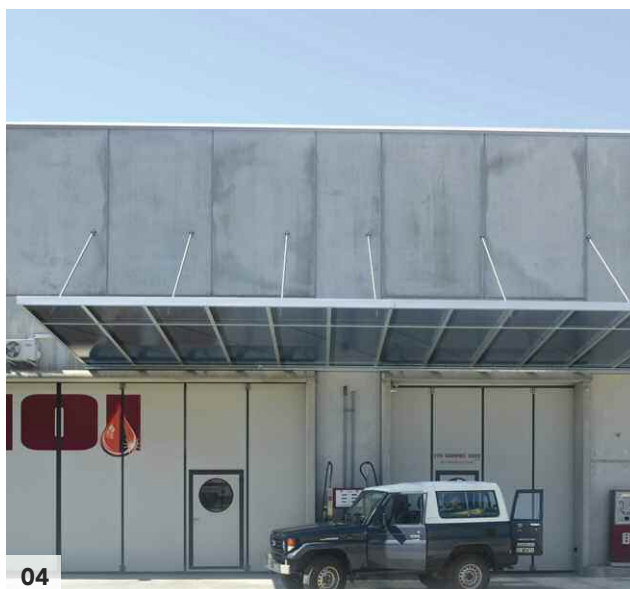

Service
de montage en
Suisse romande

Caractéristiques principales

Structure statique composée de tirants spéciaux ancrés à la façade du bâtiment

Couverture supérieure en profilés d'aluminium.
Finition en aluminium anodisé ou en teinte gris anthracite

Plaques de recouvrement en plexiglas alvéolaire Röhm SDP 16 mm – 2 teintes à choix

Sur demande: dimensions et constructions spéciales, teintes RAL

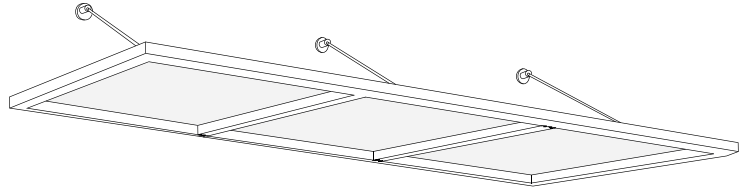

Mod. LUX CPK 087

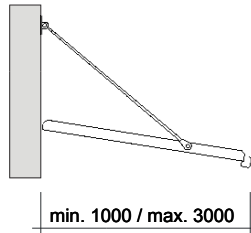

min. 1000 / max. 3000

Mod. LUX CPK 087 + TE30

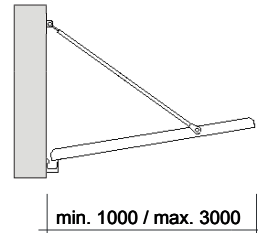

min. 1000 / max. 3000



06



07



08



09



10



11



01

Couverts pour escaliers et passages

Couvertures spécialement réalisées pour la protection d'escaliers et de passages pour piétons.

Chaque structure est construite sur mesure et respecte les contraintes statiques du lieu où elle sera installée.



02



03



04



05



Service
de montage en
Suisse romande

Caractéristiques principales

Structure portante composée de colonnes et traverses en profilés d'acier zingué à chaud ou sablé et thermolaqué

Couverture supérieure en profilés d'aluminium; chéneau portante TE30 et extrudés de fermetures. Finition en aluminium anodisé ou en teinte Perlgrimm gris anthracite

Plaques de recouvrement en plexiglas Röhm XT 4 mm – 4 teintes à choix; ou en plexiglas alvéolaire Röhm SDP 16 mm – 2 teintes à choix

Sur demande: dimensions et constructions spéciales, teintes RAL, prédisposition illumination LED



06



07



08



09



10



11



12



13



14



15



16



17



18

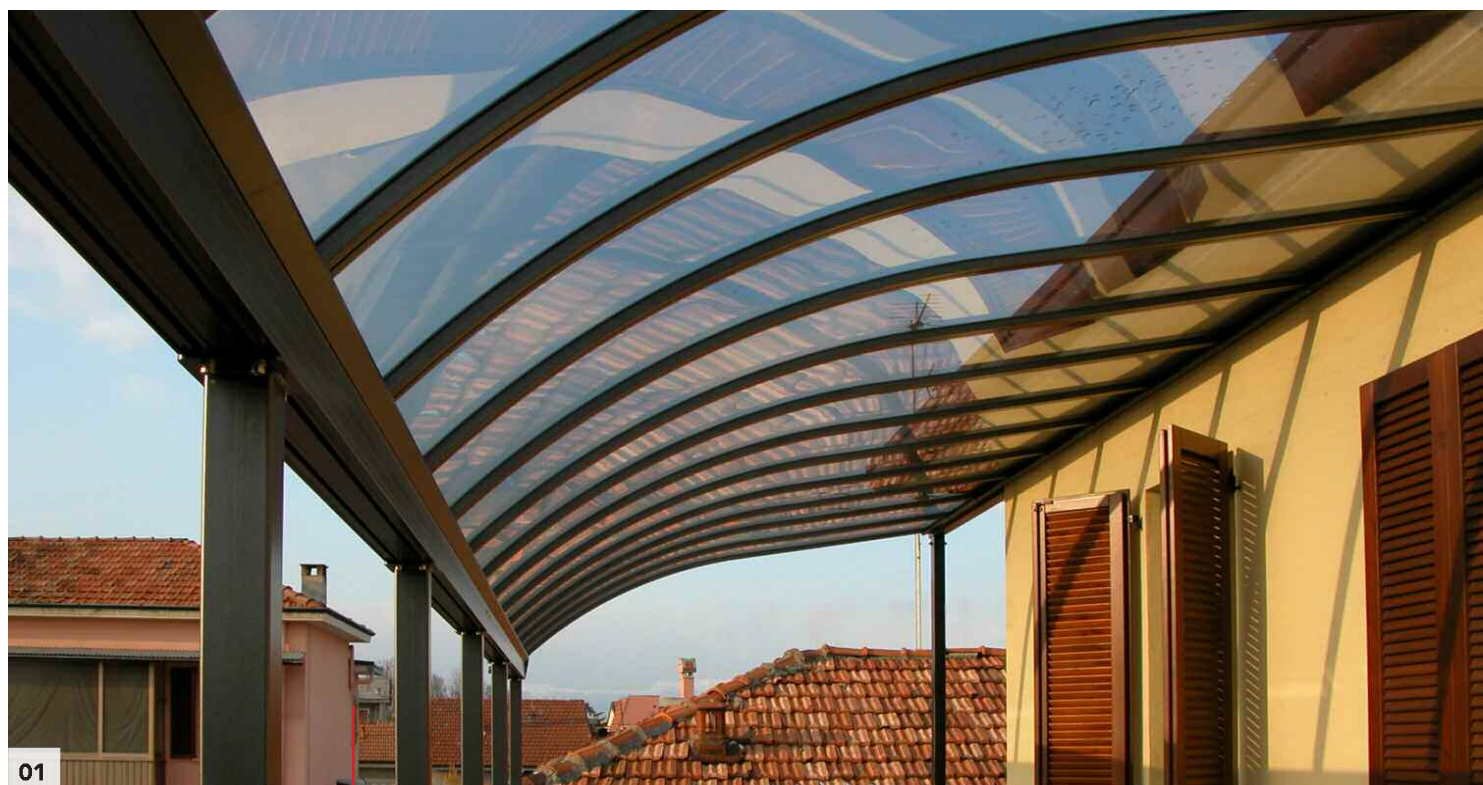

01

Couverts à terrasses série R

Couvertures en forme d'arcs, idéales pour protéger vos terrasses et zones relax extérieures.

Chaque structure est construite sur mesure et respecte les contraintes statiques du lieu où elle sera installée.



02



03



04



05



Service
de montage en
Suisse romande

Caractéristiques principales

Structure portante composée de colonnes et traverses en profilés d'acier zingué à chaud ou sablé et thermolaqué

Couverture supérieure en profilés d'aluminium; chéneau portante TE30 et extrudés de fermetures. Finition en aluminium anodisé ou en teinte Perlgrimm gris anthracite

Plaques de recouvrement en plexiglas Röhm XT 4 mm – 4 teintes à choix

Sur demande: dimensions et constructions spéciales, teintes RAL

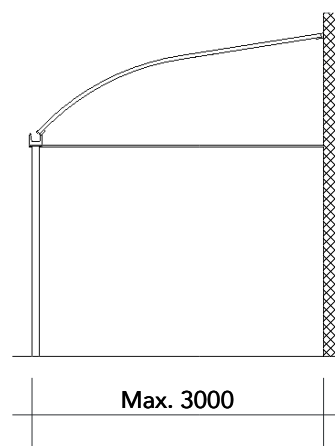
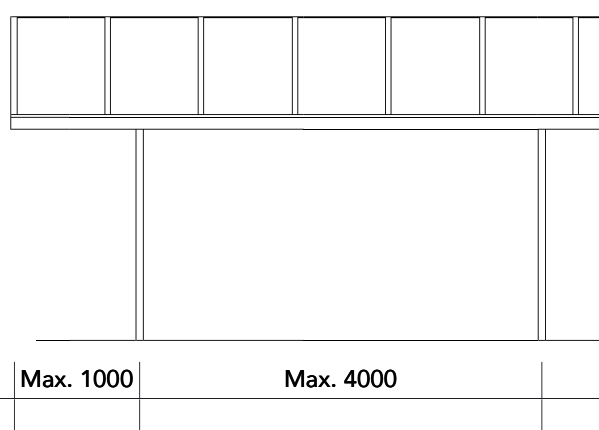

Accessoires

Parois latérales en verre ou plexiglas

Prédisposition illumination LED





01

Couverts à terrasses série F

Couvertures plates, idéales pour protéger vos terrasses et zones relax extérieures.

Chaque structure est construite sur mesure et respecte les contraintes statiques du lieu où elle sera installée.



Service
de montage en
Suisse romande

Caractéristiques principales

Structure portante composée de colonnes et traverses en profilés d'acier zingué à chaud ou sablé et thermolaqué

Couverture supérieure en profilés d'aluminium; chéneau portante TE30 et extrudés de fermetures. Finition en aluminium anodisé ou en teinte Perlgrimm gris anthracite

Plaques de recouvrement en plexiglas alvéolaire Röhm SDP 16 mm – 2 teintes à choix ou de profilés d'aluminium encastrables offrant une surface visible lisse et propre; finition teinte gris RAL 7035

Sur demande: dimensions et constructions spéciales, teintes RAL

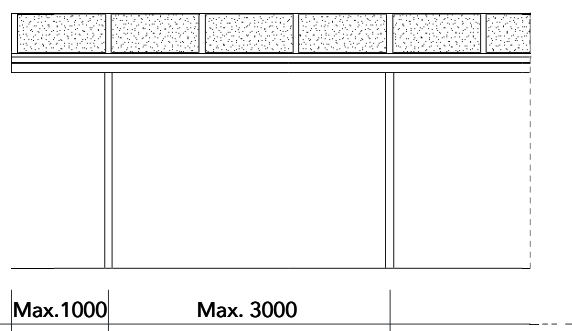

Type "A"

Type "B"

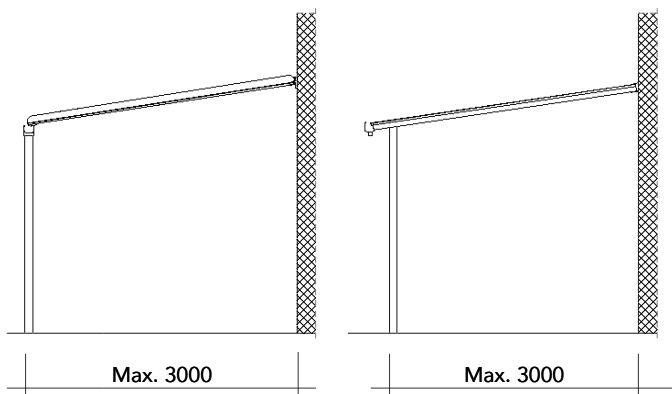

Accessoires

Parois latérales en verre ou plexiglas

Prédisposition illumination LED





01

Pergola

Pergola auto-portante avec système de protection solaire originale en tôle d'aluminium.



02



03



04



05



Service
de montage en
Suisse romande

Caractéristiques principales

Structure portante composée de colonnes et traverses en profilés d'aluminium. Plaques de base télescopique

Couverture supérieure en profilés d'aluminium; finition en aluminium anodisé ou en teinte Perlgrimm gris anthracite

Plaques de recouvrement en tôle d'aluminium déployé - teinte anodisé naturel

Sur demande: dimensions et constructions spéciales, teintes RAL

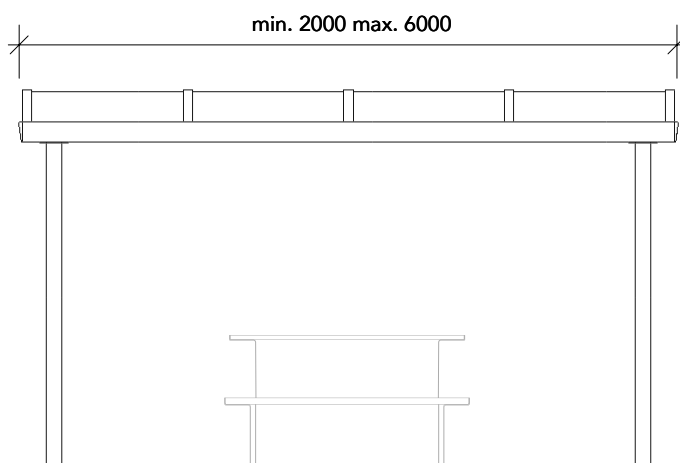
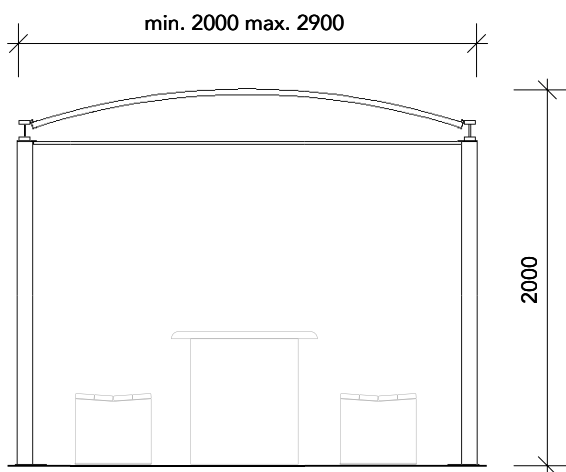



01

Couvert pour joueurs

Couvert pour terrains de sport, aux formes courbes, idéal pour les joueurs et entraîneurs



02



03



04



05



Service
de montage en
Suisse romande

Caractéristiques principales

Structure portante en profilés d'acier zingué. Pieds de fixation réglables.

Couverture supérieure en profilés d'aluminium; finition en aluminium anodisé ou en teinte Perlgrimm gris anthracite

Plaques de recouvrement en plexiglas Röhm XT 4 mm – 4 teintes à choix

Sur demande: dimensions et constructions spéciales, teintes RAL

Pieds réglables

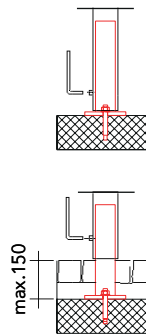

Accessoires

- Parois latérales
- Sièges avec dossier
- Roues

Série Sport

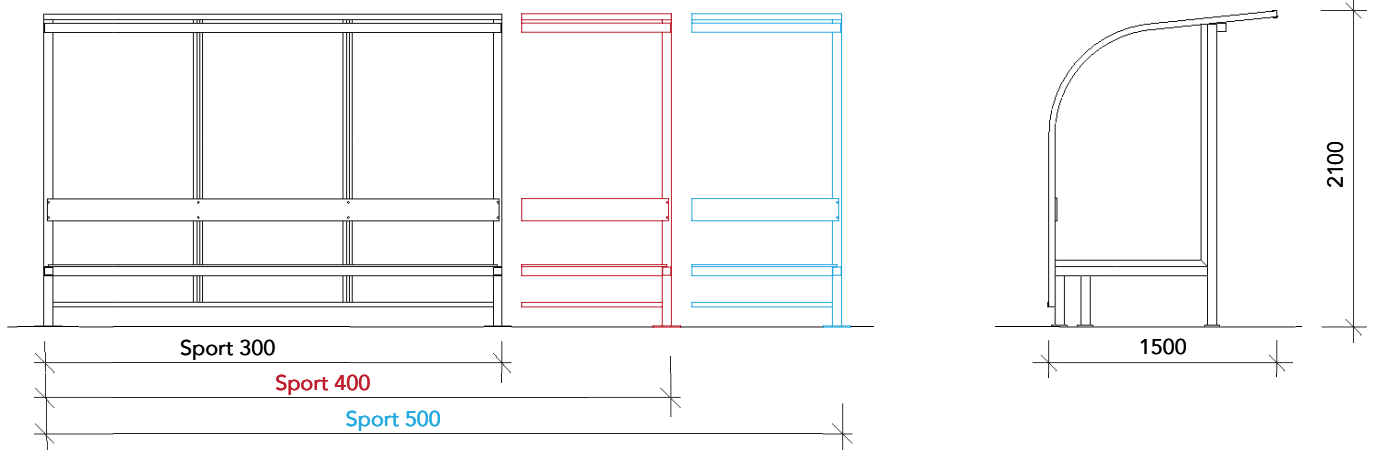

Série Sport Light

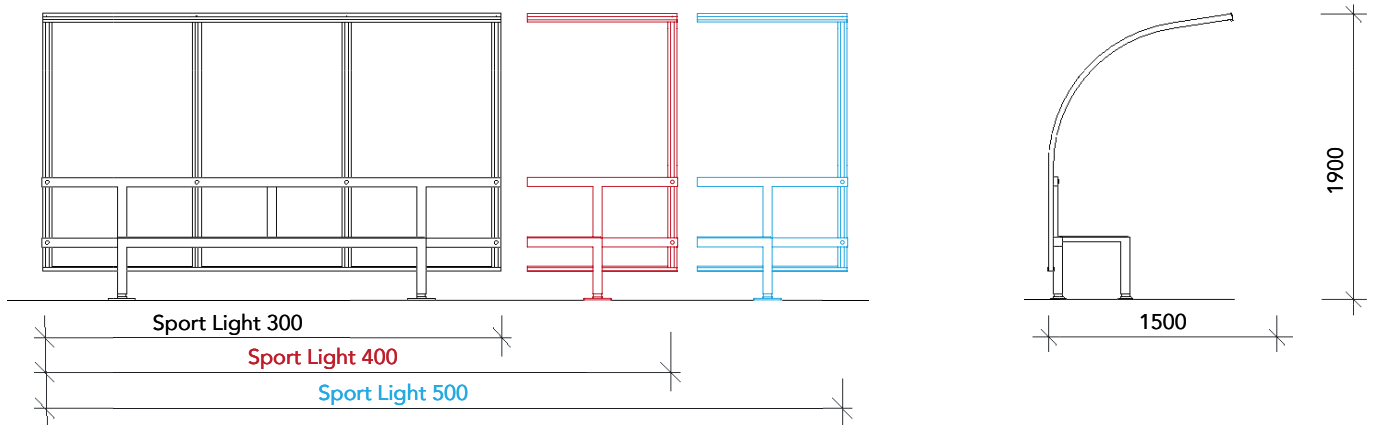

Exécutions spéciales

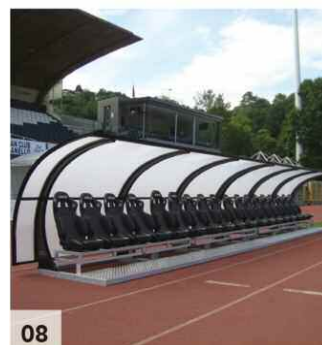



01

Couverts pour boîtes aux lettres et distributeurs

Couvertures au design harmonieux et simple.

Elles s'adaptent à tous type de boîtes aux lettres.



02



03



04



05



Service de montage en Suisse romande

Caractéristiques principales

Structure portante composée de colonnes et traverses en profilés d'acier zingué à chaud ou sablé et thermolaqué

Couverture supérieure en profilés d'aluminium; chéneau portante TE30 et extrudés de fermetures. Finition en aluminium anodisé ou en teinte Perlgrimm gris anthracite

Plaques de recouvrement en plexiglas Rhöm XT 4 mm – 4 teintes à choix; ou en plexiglas alvéolaire Röhms SDP 16 mm – 2 teintes à choix; verre sécurisé 6+6 mm

Sur demande: dimensions et constructions spéciales, teintes RAL

Modèle Linea

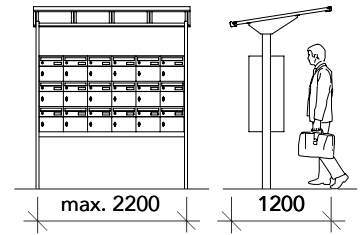

Modèle Eco

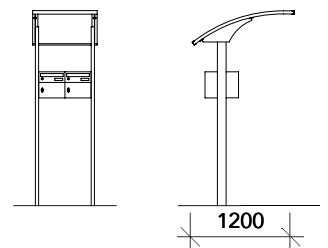

Modèle VE

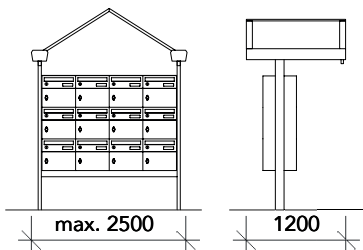

Modèle VR

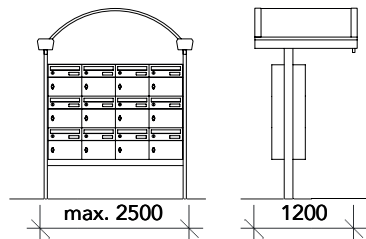

Modèle Arco

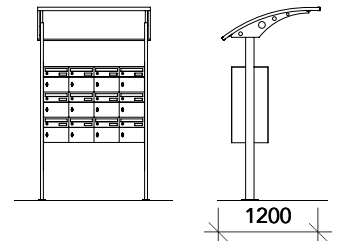

A Z

sa

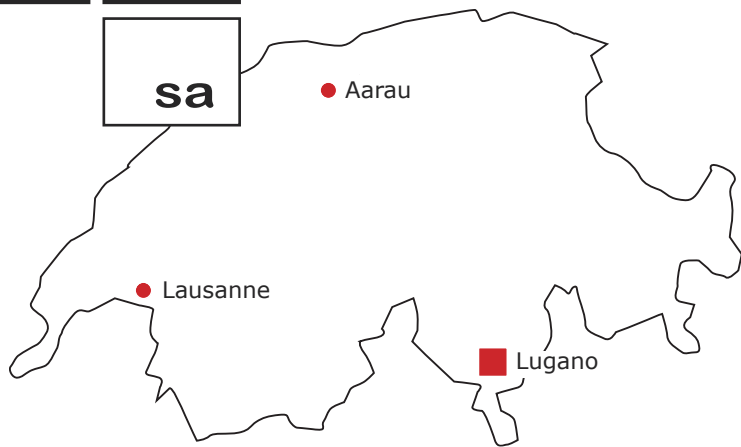



CH - 6930 BEDANO
 via Industrie 18
 tel. 091.945.41.14
 fax 091.930.91.90

www.az-sa.ch
 info@az-sa.ch

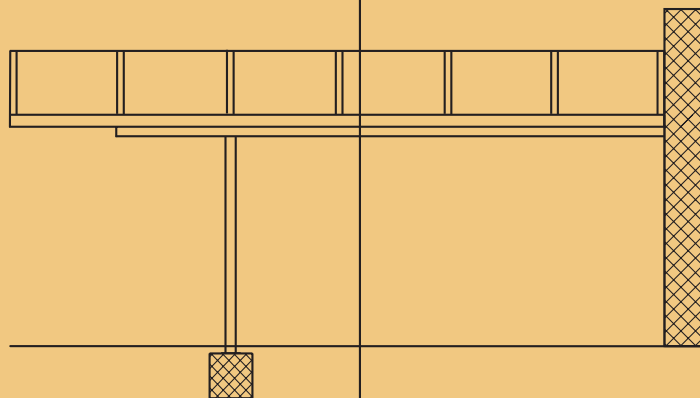
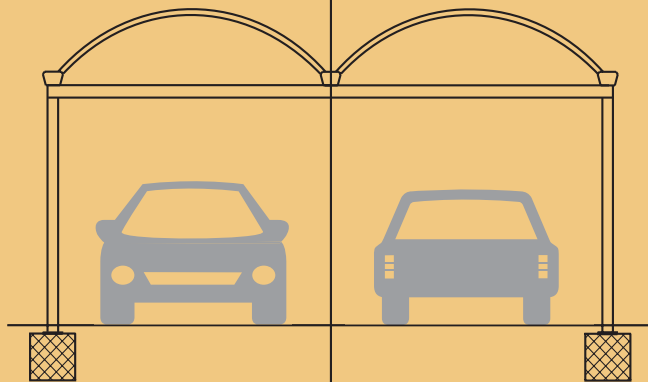

Sitzbänke
 Abfallbehälter
 Planzentröge
 Baumschutzsystem
 Brunnenanlagen
 Spielplatzgeräte
 Sperrpfosten
 Schaukasten, Vitrinen
 Buswartehalle



Bancs
 Poubelles
 Bacs à fleurs
 Grilles pour arbres
 Fontaines
 Parcs de jeux
 Potelets de délimitation
 Vitrines
 Abribus

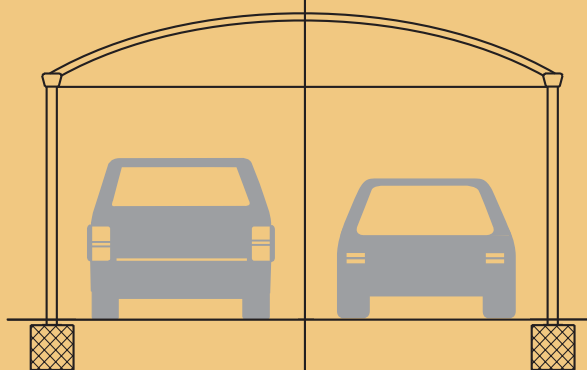

Panchine
 Cestini portarifiuti
 Fioriere
 Griglie protezione alberi
 Fontanelle
 Parchi gioco
 Paletti di delimitazione
 Vettrine, albi d'affissione
 Pensiline attesa bus

